













SR5602 - KR5602

PORTAPACCO SPECIFICO - SPECIFIC HOLDER - PORTE-PAQUET SPÉCIFIQUE - SPEZIFISCHER TRÄGER - PORTA-EQUIPAJE ESPECÍFICO

PIAGGIO TYPHOON 50-125cc (2011)

N°	Descrizione	Caratteristiche	Codice	Quantità	
1	Supporto - Support - Support Halierung - Soporte		GL2001	2 (Dx,Sx)	
2	Supporto - Support - Support Halierung - Soporte		-	2 (Dx,Sx)	
3	Supporto - Support - Support Halierung - Soporte		GL1387	1	
4	Vite - Screw Vis - Schraube Tornillo	TEF M6x20		4	
5	Vite - Screw Vis - Schraube Tornillo	TEF M8x50		2	
6	Vite - Screw Vis - Schraube Tornillo	TEF M8x20		2	
7	Vite - Screw Vis - Schraube Tornillo	TSCEI M8x40		2	
8	Dado - Bolt - Ecrou Mutter - Tuerca	Auto Bloccante Flangiato M6		2	
9	Dado - Bolt - Ecrou Mutter - Tuerca	Auto Bloccante Flangiato M8		2	
10	Distanziale - Spacer Entretoise - Distanzstueck Distanciador	Ø18x30 foro 8.5mm	V793	2	
11	Distanziale - Spacer Entretoise - Distanzstueck Distanciador	Distanziale in tubo 16x2 h10/10°	V831	2	
12	Gomma Sagomata - Rubber Cushion Caoutchouc Profile - Geformte Gummi Goma Protectora	sp. 2mm	Z2157	2	
13	Particolari Inclusi Nel Kit Viteria Della Piastra Components Included In The Fitting Kit Of The Plate Pièces Incluses Dans Le Kit De Vis De La Platine Die Einzelnen Teile Sind Bei Montagekit Der Platte Enthalten Despieces Incluidos En El Kit De Anclajes De La Parrilla				

SR5602 - KR5602

PORTAPACCO SPECIFICO - SPECIFIC HOLDER - PORTE-PAQUET SPÉCIFIQUE - SPEZIFISCHER TRÄGER - PORTA-EQUIPAJE ESPECÍFICO

PIAGGIO TYPHOON 50-125cc (2011)

ATTENZIONE: CARICO MASSIMO 3Kg
WARNING: MAX LOAD, 3Kg.
ATTENTION: CHARGE MAXIMUM, 3Kg.
ACHTUNG: MAX. 3Kg.
¡ATENCIÓN!: CARGA MÁXIMA, 3Kg.

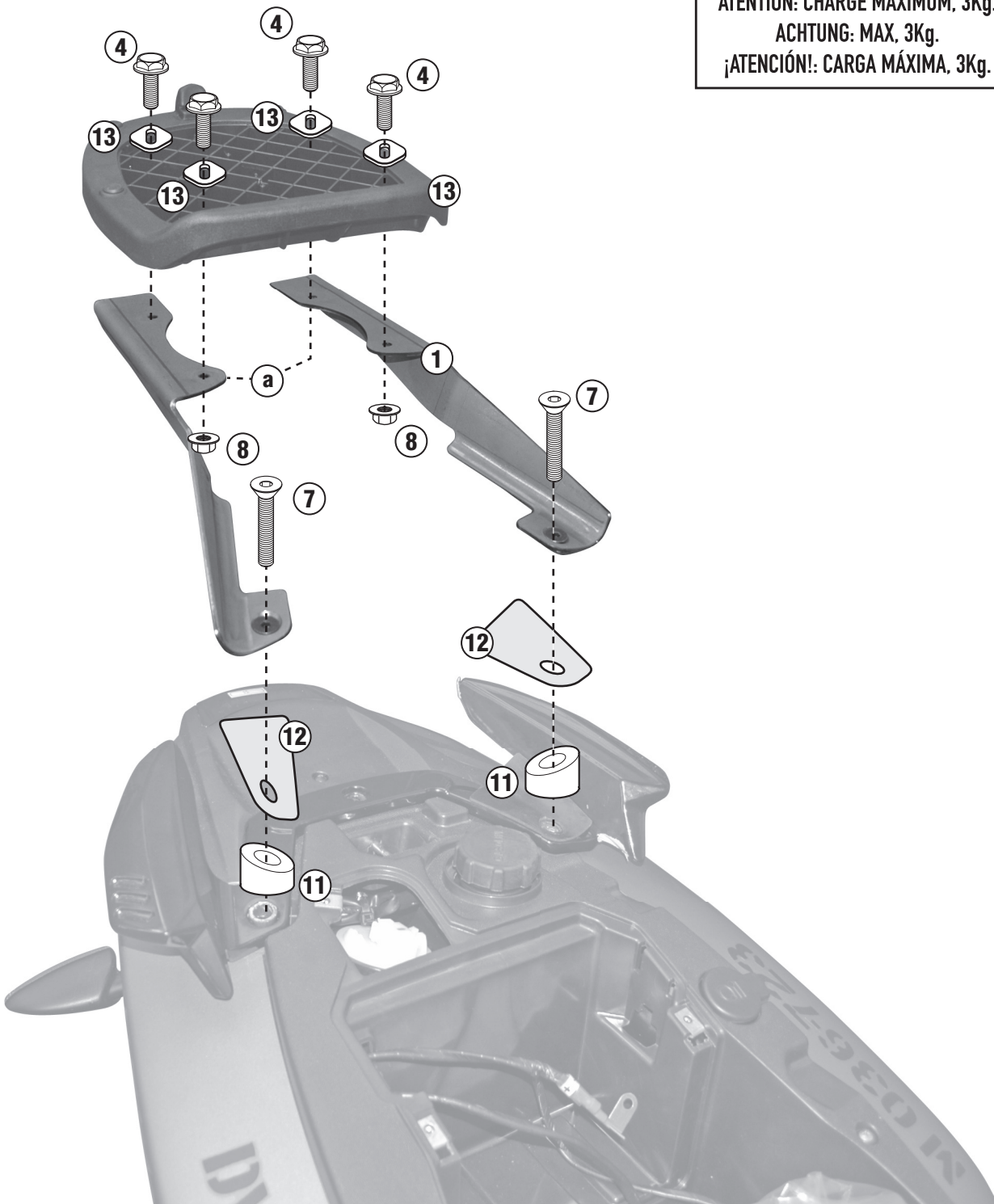

SR5602 - KR5602

PORTAPACCO SPECIFICO - SPECIFIC HOLDER - PORTE-PAQUET SPÉCIFIQUE - SPEZIFISCHER TRÄGER - PORTA-EQUIPAJE ESPECÍFICO

PIAGGIO TYPHOON 50-125cc (2011)

