



POWERSPORTS BATTERY Maintenance-Free AGM Battery Series

CTX4L-BS 12V 3AH(10HR)



JIS
D5302

Specification

BATTERY TYPE NUMBER	VOLTAGE (V)	CAPACITY AH (10HR)	CCA @-18°C	MAXIMUM DIMENSIONS						WEIGHT			
				MILLIMETERS(±2 mm)			INCHES (±1/16 in)			BATTERY ONLY		INCLUDE ACID AND PACKAGE	
				L	W	H	L	W	H	Kg	Lbs	Kg	Lbs
CTX4L-BS	12	3	50	113	70	87	4 7/16	2 3/4	3 7/16	1.25	2.75	1.84	4.05

Dimension

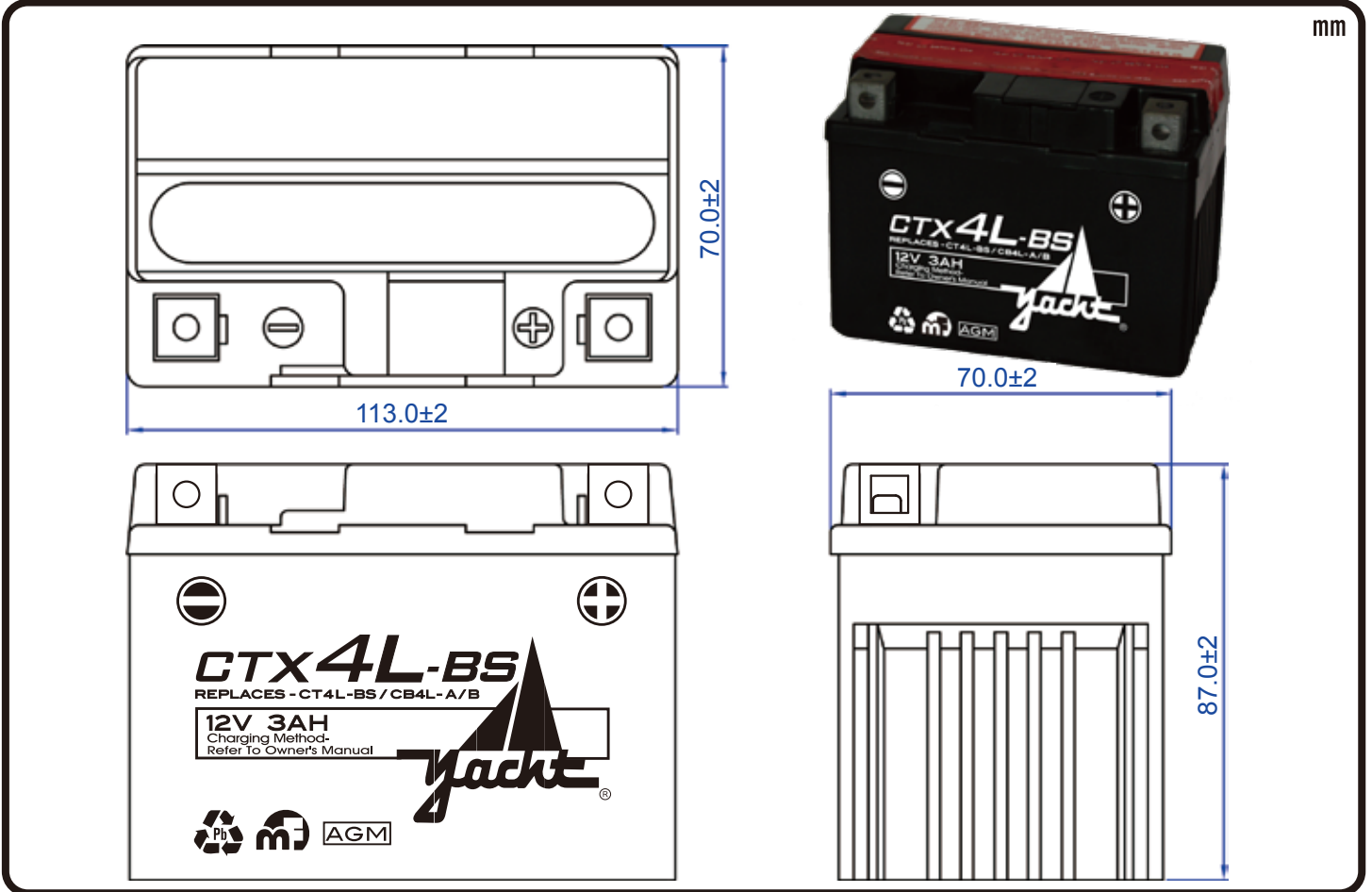

Terminal Configuration

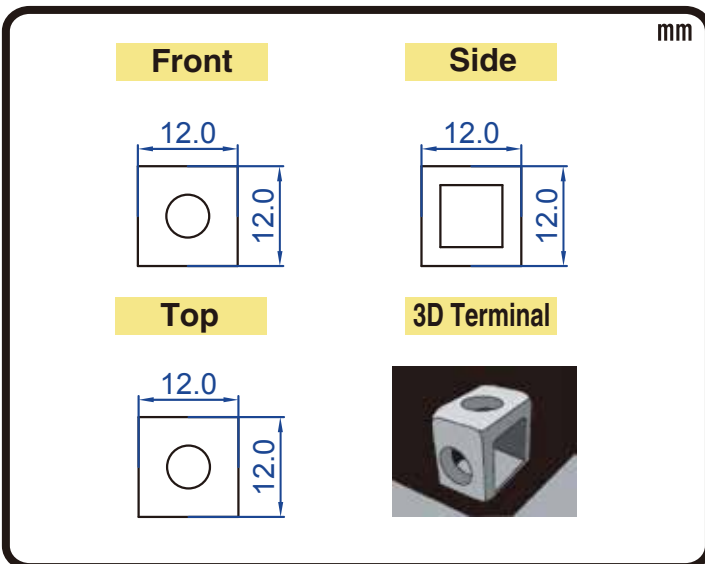

Nut & Bolt Hardware Kits

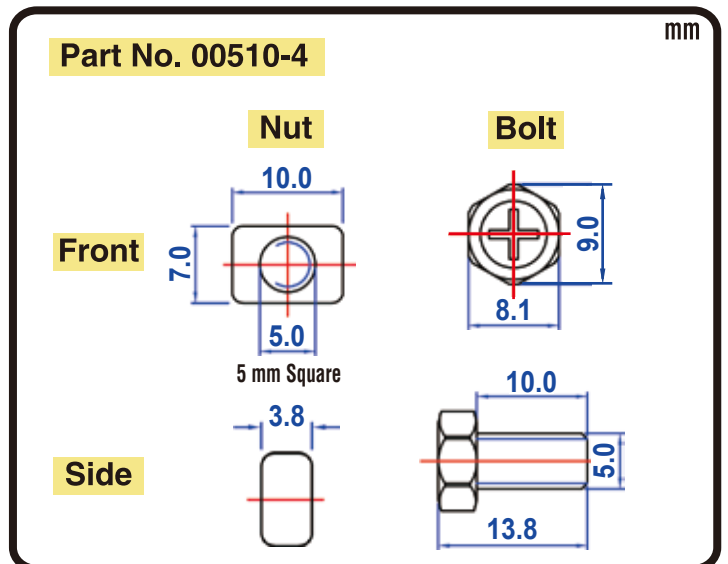

CORPORATE HEADQUARTERS (TAICHUNG, TAIWAN)

4F-5, No. 925, Sec. 4, Taiwan Blvd., Taichung, 40767 Taiwan, R.O.C.
Tel : 886-4-2358-0578 Fax : 886-4-2358-0059
sales@yacht-battery.com

YACHT BATTERY USA, INC.

Tel : 1-610-689-0443 Fax : 1-888-373-6466
Dave.Beidler@yacht-battery.com
Bruce.Ash@yacht-battery.com